

Wireless
Fiber Optic
Secure WAN
Remote Power
Ethernet Switches
IP over Coax & UTP
Mobile Surveillance

KBC
data delivered

KBC Transmission & Remote Power Products

www.kbcnetworks.com



Version 0319

KBC designs and delivers tried, tested and trusted transmission, remote power & mobile solutions for your application.



ThruLink: Industrial VPN for encrypted and secure WAN transmission

Transmits IP signals over any type of WAN/LAN
 Embedded 4G/LTE version for streaming secure live video from vehicles
 Supports meshed networks; flexible & scalable
 Supports FIPS, Blowfish, AES & Camellia encryption, up to 256 bit
 Auto-reconnects if the network connection fails, multiple failover.



Media Converters: maximum flexibility provided through multiple options

10/100/1000Mbps media converters, Single mode and multimode
 PoE & SFP options available
 Compact size, Industrial rating
 Mounting configurations include Wall, DIN Rail & 2U High Rack Chassis options

eCopper™



EoC/EoU – eCopper™ – a simple way to transmit Ethernet over Coax or UTP

1,4,8 and 16 Channel models
 Transmit up to 1,200 Feet PoE+
 Transmit up to 2,600 Feet PoE
 Current protection
 POC Management



Switches: Managed and Unmanaged, PoE, PoE+, PoE++, Daisy Chain & Ring Configuration

Feature Rich
 Reliable High Performance
 Rugged IP40 Design
 Easy to Configure
 Supports ERPS
 Wide range of industrial SFPs available

Remote Power & Mobile Surveillance

A full range of solar, wind and remote power solutions including UPS, power kits, power supplies & accessories

AL2/AL5 Off-Grid power
 UAL2/UAL5 Backup Power 24/7
 MSS Temporary Surveillance
 SPB Engineered Power



Wireless

WES3 & WES3 HTG Point to Point, Point to Multi-Point & Mesh topologies

WES3HTG – gigabit wireless 1.3 Gbps aggregate, 650 Mbps directional throughput
 WES3 – standard 99 Mbps throughput – versatile and easy setup
 Feature rich enhanced firmware
 25 years of secure, reliable no-dig solutions
 Simple to use kit packaging



Fiber Optic

A full line of Digital Standard and ASFOM fiber optic products

Digital Standard – building blocks for point to point video, audio and data transmission
 ASFOM – Application Specific Fiber Optic Modules – custom configurable for the most demanding applications
 Wide range of industrial SFPs available



Secure transmission over public networks

Encrypted transmission over the Internet, 3G/4G/LTE

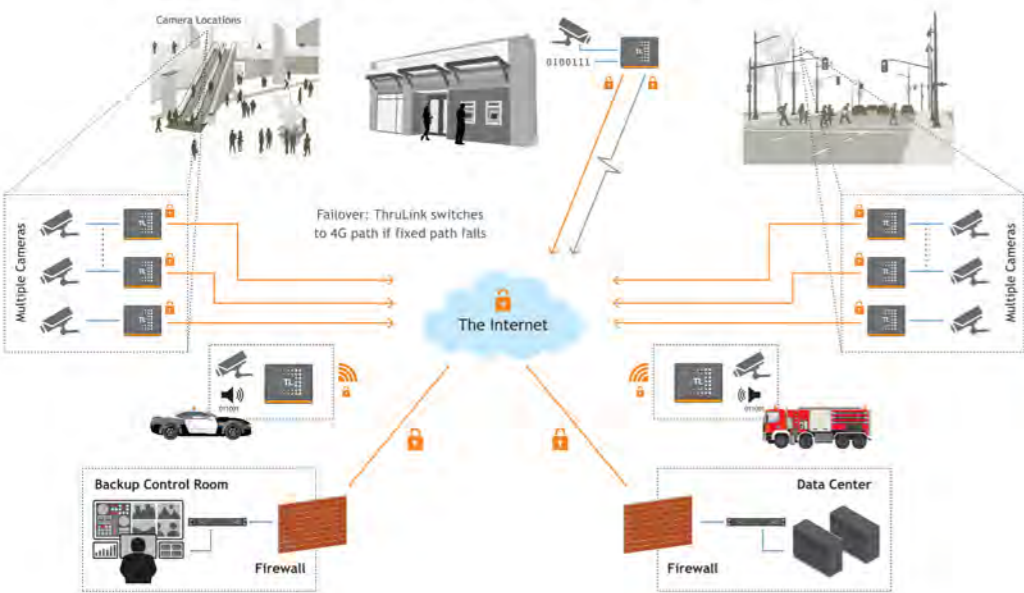

Wireless transmission

Point-to-point, point-to-multipoint, mesh & 4G/LTE

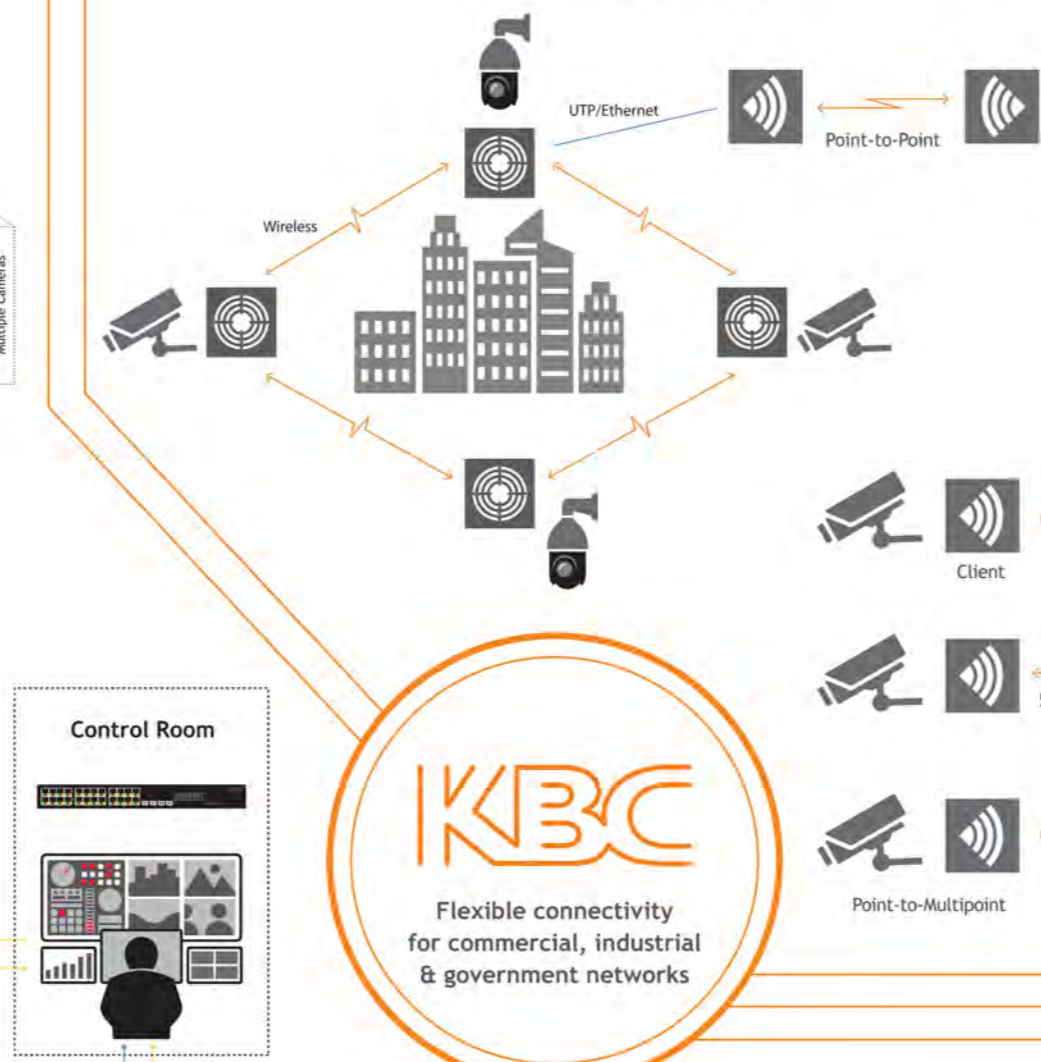

Remote power solutions

Solar, wind, UPS & PoE power kits

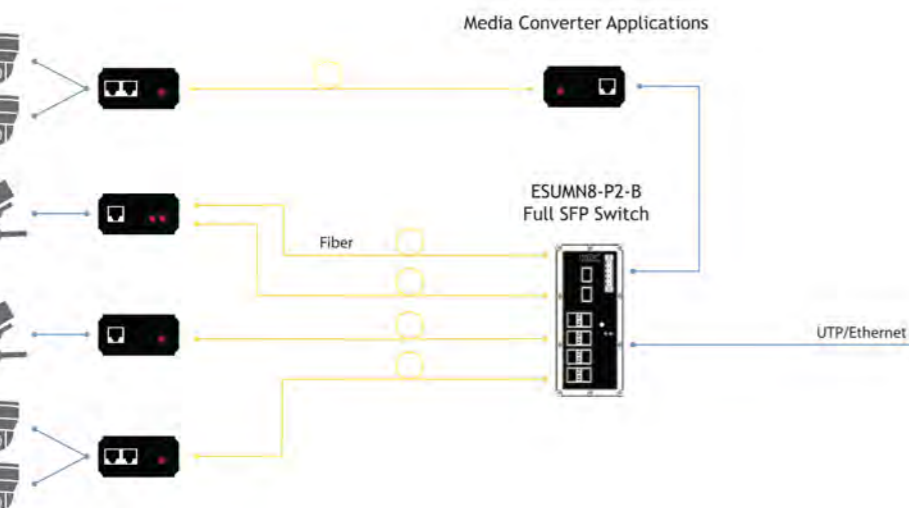
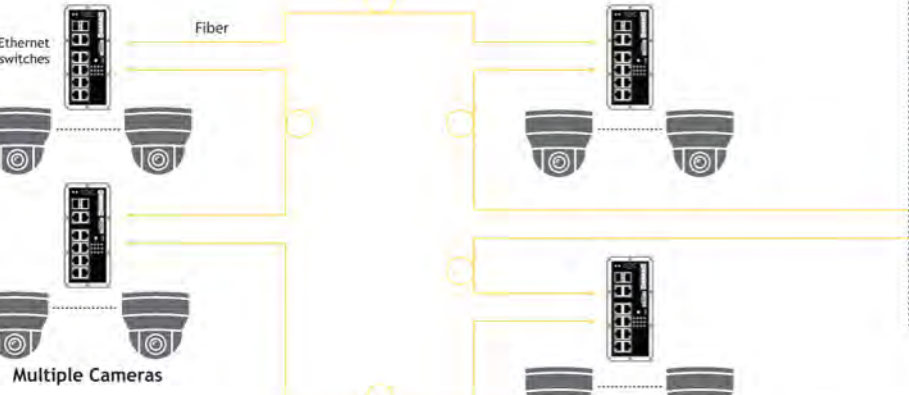
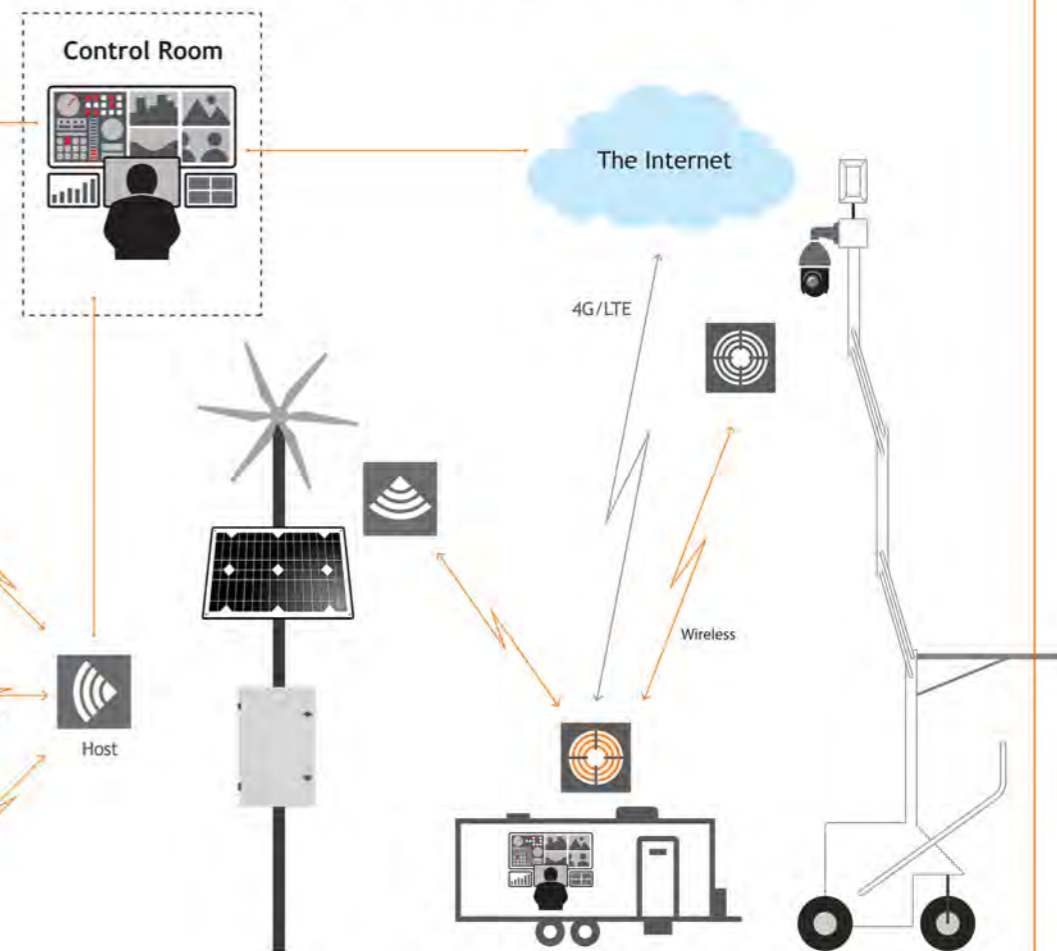

Ethernet over Coax (EoC) Applications

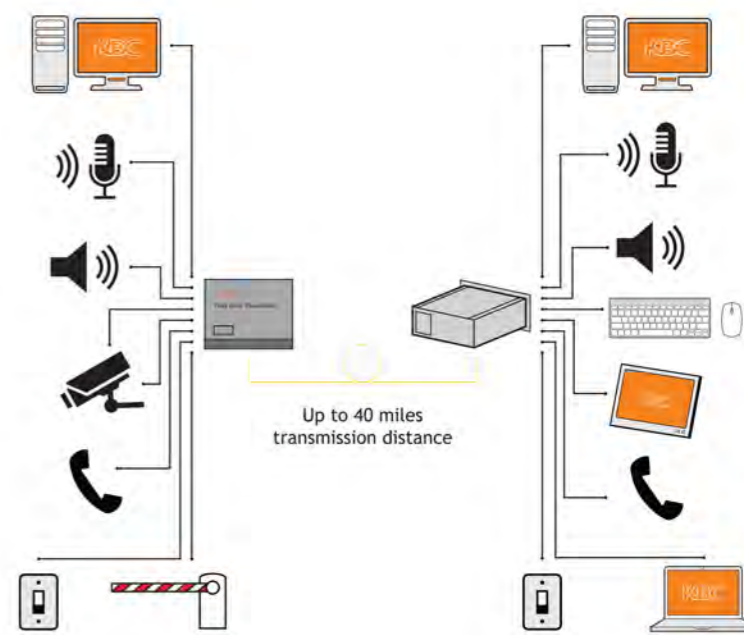
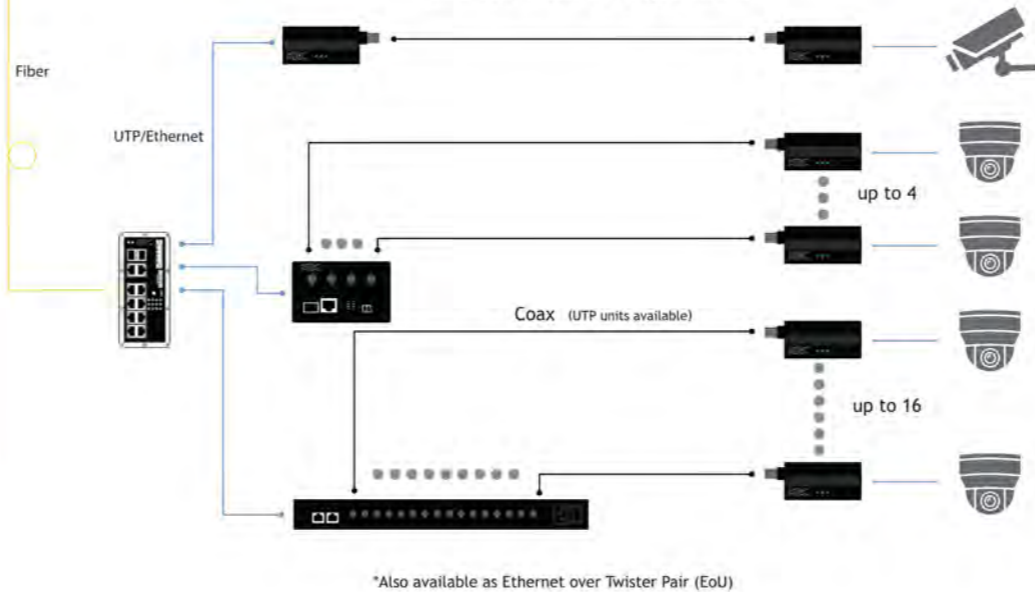

IP transmission

Ethernet switches, media converters, encoders & decoders, Ethernet extenders, SFPs, and 4G/LTE

Fiber optic transmission

Video, audio, data, contact closure, Ethernet, telephone, DVI, HD-SDI, 3G-SDI, USB



Transmission for a wide range of applications and markets

KBC industrial products are built to perform in non-conditioned environments, featuring wide operating temperatures and hardened casings.

Applications

- CCTV & surveillance
- Security
- Intelligent Transport Systems (ITS)
- Telemetry & SCADA
- Industrial control
- Access control systems
- Remote video, voice & data transmission
- Building & site management

Verticals

- Town & city center
- Transportation
- Critical National Infrastructure
- Petrochemical
- Power & utilities
- Government agency
- Military systems
- Counter-terror
- Homeland security
- Remote data
- Emergency services
- Commercial & retail
- Residential



Integrity

Maintaining close, individual relationships with our customers and partners is our top priority. Everything we do as a company—and as individuals—is handled with complete integrity and respect.

Service

Superior service and support is a critical component of our business. We believe that successful network and system performance rely on accurate design and correct installation, so our technical and sales teams provide product support throughout the lifecycle of every project. Please contact us for customised pre-sales and technical support.

Quality

Reliability and high performance are at the core of our design, engineering and manufacturing processes. KBC is proud to offer products and services that go above and beyond recognized international standards.

More Products

We've included our major product groups in this brochure. For further detail about the complete range, please visit our website: www.kbcnetworks.com, or call your local representative.

Better Installation

We spend time thinking about our products so you don't have to. KBC products are designed for straightforward set-up; simple analysis and minimal maintenance.

Greater Performance

Our products are built to perform in commercial and industrial environments. Our industrial ranges feature extended operating temperatures and industrially-hardened casings to withstand temperature extremes and the rigors of industrial and outdoor environments.

North America

KBC Networks
Brookline 15
Aliso Viejo, CA 92656
USA
Phone: +1 949 297 4930
Toll Free: +1 888 366 4276
Fax: +1 949 297 4933
info@kbcnetworks.com

Latin America

KBC Networks
Luis G. Inclán 2859
Villa de Cortés
Mexico City, 03530
Mexico
Phone: +52 33 3148 3286
latam@kbcnetworks.com

EMEA (Europe, Middle East & Africa)

KBC Networks
The Nucleus
Brunel Way, Dartford,
Kent, DA1 5GA
United Kingdom
Phone: +44 (0) 1322 312090
emea@kbcnetworks.com

Asia Pacific

KBC Networks
81 Nan Xijiang East Road
Room 919
Nanjing, Jiangsu 210019
China
Phone: +86 25 5882 1656
apacinfo@kbcnetworks.com